

FORMAX[®]

FD 380

Document Folder

OPERATOR MANUAL
FIRST EDITION

TABLE OF CONTENTS

SUBJECT	PAGE
DESCRIPTION	1
SPECIFICATIONS	1
UNPACKING	1
SETUP	2
CONTROL PANEL	3
OPERATION	4
SETTING CUSTOM FOLDS	5
BATCH COUNTING	6
MULTI-SHEET FEEDER	6
CROSS FOLDING	7
STACKER WHEEL POSITIONING CHART	7
OPERATOR MAINTENANCE	8
TROUBLE-SHOOTING	9







DESCRIPTION



FUNCTION

The FD 380 Folder is designed to perform a wide variety of folds using a variety of paper weights. The fold plates are automatically adjusted for standard folds and custom folds. Documents that are 8 ½" x 14" and 11" x 17" are detected by sensors on the in-feed tray. Batch counting, self-centering side guides, and the capability to cross-fold are added features. There are six pre programmed standard folds and up to nine custom folds available. The folder will automatically stop after the last document has been folded.

SPECIFICATIONS

Paper size:	3.5" X 5" TO 11" X 17"
Fold types:	Letter  , Zig-Zag  , Single  , Gate  , Fold Out  , Double Parallel  and Custom Folds
Feed table capacity:	500 sheets of 20# paper
Processing speed:	Up to 12,500/hour, depending on fold type.
Power requirements:	120 volts A.C., 50/60 Hz, 2 amps.
Dimensions during use:	60"long, 20" wide, 19" high.
Weight:	77 lbs

UNPACKING

1. Check package for shipping damage. If there is shipping damage, do not discard the box.
2. Remove the machine and packed components from the box. The fold plates, telescoping stacker, power cord and cross-fold guide are wrapped separately in the box.

NOTE: Two people must lift the machine from the box.

3. Place the machine on a solid stand.
4. Attach telescoping outfeed stacker.

SETUP

1. Install upper and lower fold plates in position. Be sure the plates are set firmly on the locating pins (Fig 1a & 1b). Slide the fold plate in until it meets the first locating pin then push down to lock it in position (Fig. 2).
2. Plug the fold plate cables in to the receptacles on the side frame (Fig. 3a & 3b).
3. Make sure the power switch is in the "OFF" position.
4. Plug the power cord into the power inlet and the wall outlet.

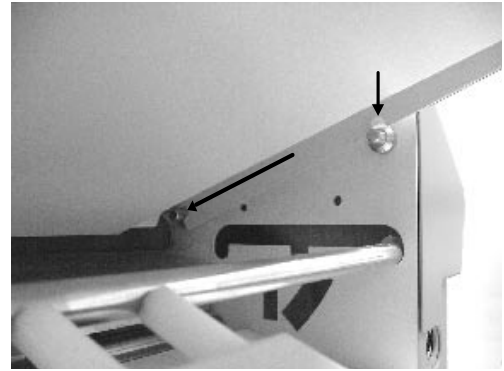

Fig. 2

Upper Fold Plate Receptacle Location



Fig. 3a

Plug in Receptacle

Upper Fold Plate Pins

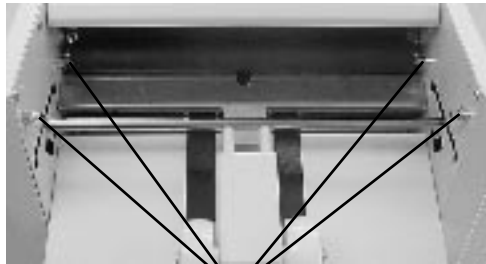

Fig. 1a

Locating Pins

Lower Fold Plate Pins

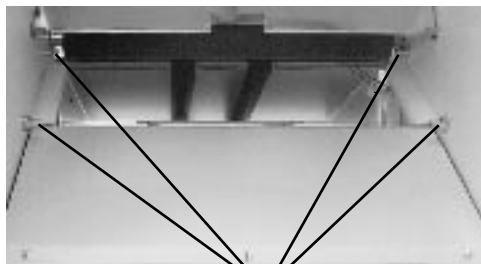

Fig. 1b

Locating Pins

Lower Fold Plate Receptacle Location



Fig. 3b

Plug in Receptacle

CONTROL PANEL

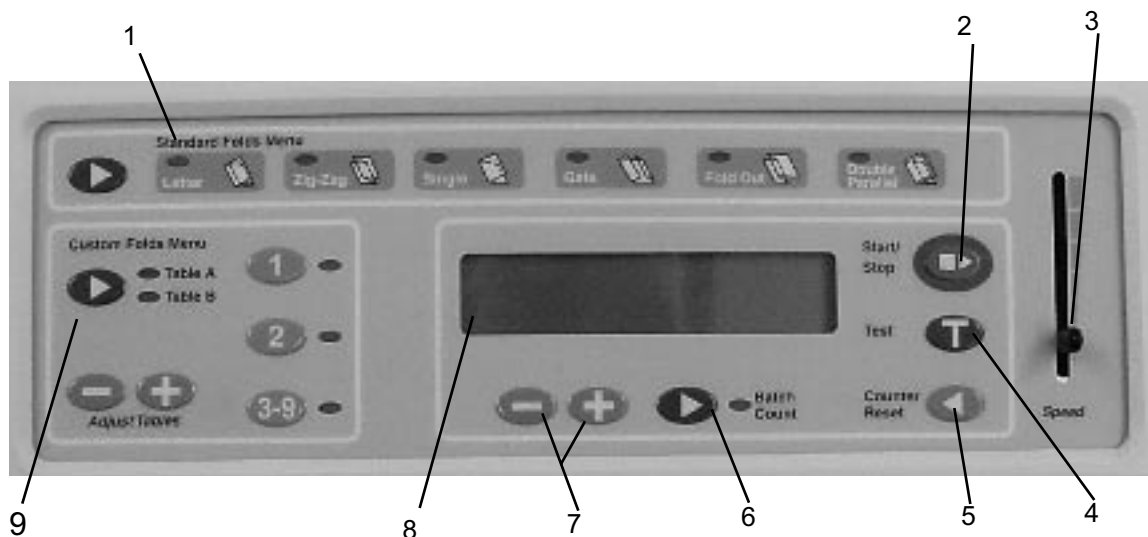

No.	NAME	FUNCTION
1	Standard Folds Menu	Select the desired pre programmed fold.
2	Start/Stop Button	Press to start or stop the machine.
3	Speed Control Lever	Select the speed to run the machine.
4	Test Button	Test folds one document.
5	Counter Reset Button	Resets the counter and clears fault indications.
6	Batch Count Button	Select the batch counting function.
7	"-" and "+" buttons	Select the number of documents to be folded.
8	Display Screen	Shows the number of documents processed and the type of fold being used.
9	Custom Folds Menu	Select and program a custom fold (see page 5).

OPERATION

1. Place power switch in the "ON" position.
 2. Extend the catch tray as required.
 3. Move the stacker wheels to the proper position for the paper size (Fig. 4)
 4. Raise the in-feed tray lever.
 5. Set the paper side guides for the paper you're using and lock in position (Refer to chart on page 7).
 6. Neatly stack paper on the in-feed tray.
 7. Lower the in-feed tray lever.
 8. Select the type of fold desired (Fig 5).
 9. Press the "Test" button on the control panel to check the folds. Fine adjustments can be made with the adjustment knob at the end of the plate (Fig 6).
- NOTE:** When the "Test" or "Start" button is pressed, the fold plate stops go to the "home" position then reposition to the programmed setting.
10. If the fold is skewed, lower the paper table extension and turn the skew adjustment knob left or right to make corrections (Fig 7).
 11. Once you're satisfied with the test folds, press the "Start" button to operate the machine.
 12. Adjust machine speed to desired level.

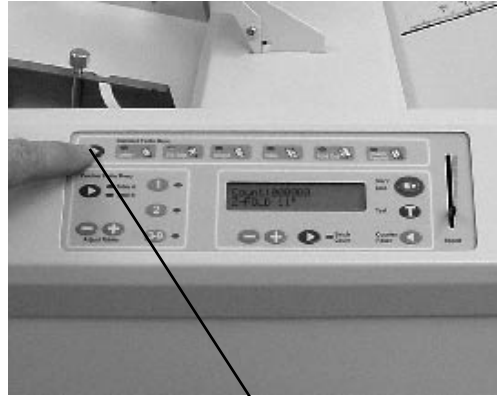

Fig. 5 Fold selection button

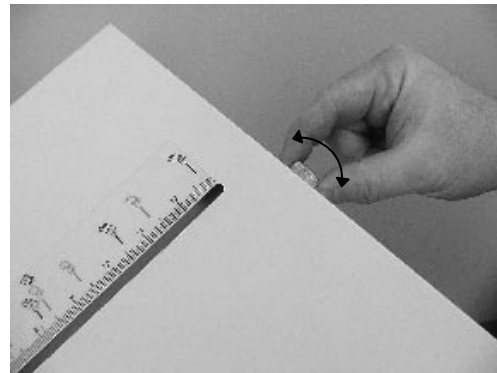

Fig. 6

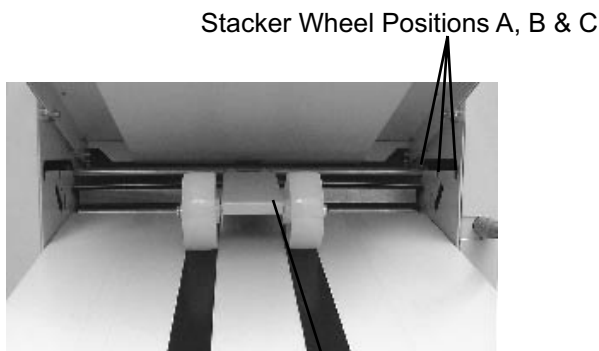

Fig. 4

Stacker Wheels



Fig. 7

Skew Adjuster

SETTING CUSTOM FOLDS

1. Measuring Fold Lengths

Example 1: Uneven “Z”

- Measure the length of panel “A”.
- Measure the length of panel “B”
- Enter these measurements according to the instructions below.

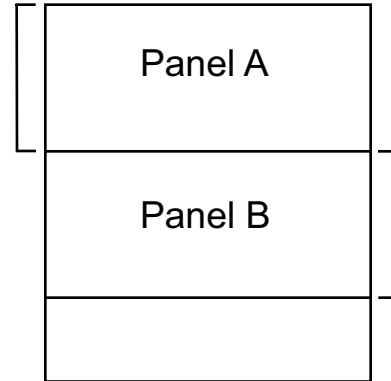

Example 2: Uneven “C”

- Measure the length of panel “A” & “B”
- Measure the length of panel “B”
- Enter these measurements according to the instructions below.

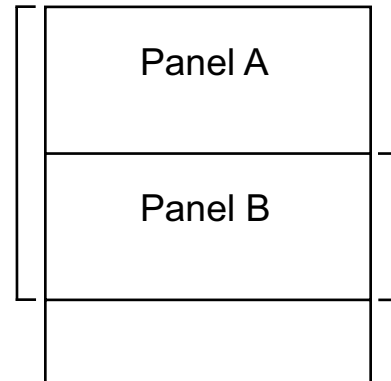

2. Programming a custom fold:

- Select the custom fold number you want to program.
- Press the green button next to the Table A and Table B lights.
Note: The display will read “TbIs A: #.## B: #.## CUSTOM #”.
Table A adjusts the upper fold plate.
Table B adjusts the lower fold plate.
The “-” and “+” buttons decrease and increase the fold numbers.
- Press the “-” and/or “+” button to enter the length of the fold. Fine adjustments can be made with the adjustment knob at the end of the plate (Fig. 5).
- Press the “Test” button to insure the proper folds have been entered.
- Once the folds are correct, press and hold the “Custom Fold” green arrow button until the machine sounds a tone. The fold has been memorized.

Note: The display screen will read “count # and custom #”.
To run your custom fold without saving it, simply press the “Start” button after step “d” above.

BATCH COUNTING

The batch counter can be set from “0” to “999”. Press the “Batch Counting” button to illuminate the “Batch Counting” light. Press the “-” or “+” buttons to select the number of documents to be folded. Press the “Start” button. When the counter gets to “0” the machine will stop.

NOTE: The batch counting program will remain on after turning the power off. You *must* press the Batch Counting button to turn off the light and cancel the batch count setting.

MULTI-SHEET FEEDING

The multi-sheet feeder is designed to fold pre-collated stapled or unstapled sets of paper of up to three 20 # sheets of paper.

1. Make sure that all paper is removed from the feed table.
2. Adjust the side guides on the feeder for the proper paper size. Loosen the brass thumb screw, open or close the guides to fit the paper width and retighten the thumbscrew (Fig 8a).
3. Slide the pre-collated paper set into the multi-sheet feeder. When feeding stapled sets the documents should be placed with the staple on the operators side and leading (Fig 9).
4. The sheets of paper will be automatically pulled into the folder (there is a one second delay after the paper is placed in the feeder).
5. If the fold is skewed, turn the skew adjustment knob located on the back of the feeder left or right to make corrections (Fig 8b).
6. To remove the multi-sheet feeder depress the release levers located on either side of the lower back side of the feeder (Fig. 10), tilt the feeder forward and lift. To reinstall depress the levers and reinsert.



Fig. 8a
Brass thumbscrew

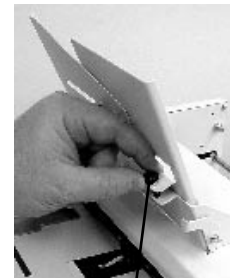

Fig 8b
Skew Adjuster

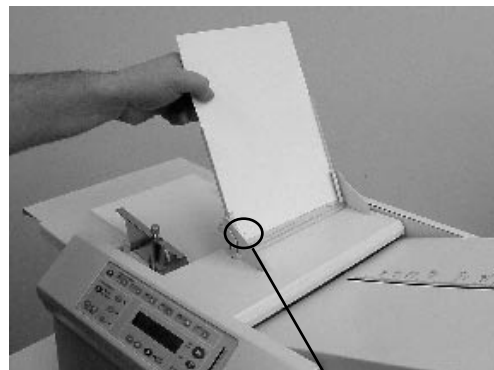

Fig. 9
Staple

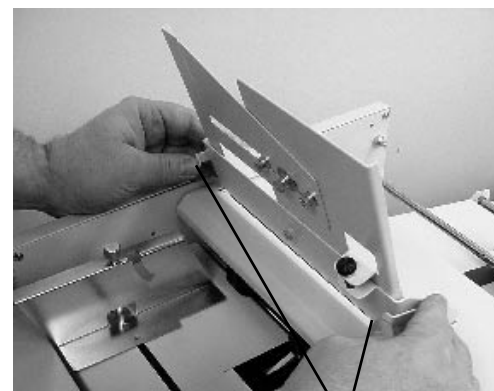

Fig. 10
Release Levers

CROSS FOLDING

Cross folding refers to folding a document in one pass and then running it through the folder a second time to be folded again.

Common Application: Folding a 11" x 17" document in half and then letter folding it to fit in a standard #10 envelope.

1. Load folded paper into the feed tray with the fold crease facing the non-operator side of the folder (Fig 11).

Note: For best results firmly run your hand over the fold crease to help flatten the paper before loading.

2. Attach the cross fold paper guide onto the feed tray paper guide (Fig. 12) and lower guide.

Note: Cross folding ability will vary based on the paper weight and type. If the paper is too heavy it may not be able to be cross folded.

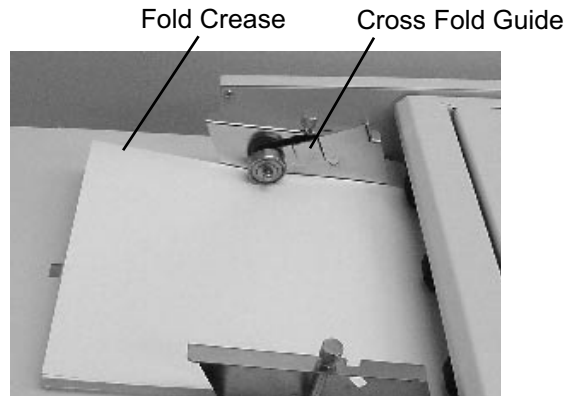

Fig. 11

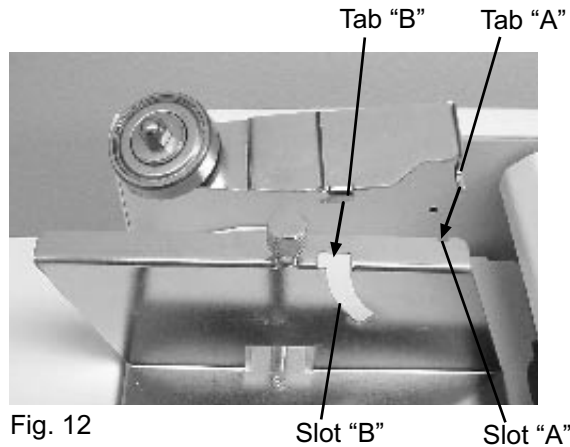

Fig. 12

To install cross fold guide hook tab "A" into slot "A" and then lower tab "B" into slot "B"

STACKER WHEEL POSITIONING GUIDE

Move the stacker wheel to the proper position indicated on the chart based on the fold and paper size.

	8.5" x 11"	8.5" x 14"	11" x 17"
Letter	A	A or B	B
Zig-Zag	A	A or B	B
Single	B	B	C
Gate	A	B	C
Fold Out	B	C	C
Double II	A	A	A or B

OPERATOR MAINTENANCE

1. It is recommended to let forms cool for one-half hour, from the laser printer, before folding. This allows toner to set on the forms and static electricity to discharge. The FD 400 Jogger is recommended for best results. The Jogger squares the forms and dissipates heat and static created by laser printers.
2. Clean in-feed tires and fold rollers with Formax recommended roller cleaner & rejuvenator to remove paper dust and toner. A Formax Cleaner Kit is available from your dealer. A damp cloth with water is the best alternative.

CAUTION: Do not use any chemicals other than the roller cleaner & rejuvenator or water.

CLEANING PROCEDURES:

1. Make sure machine is turned off and unplugged. All folders have four(4) rubber rollers (Fig. 13).
2. Remove the upper and lower fold plates .
3. Using Formax roller cleaner, spray a new cotton cloth until the cloth is saturated. Wipe the wet cloth in a back and forth motion making sure to clean the entire surface of the fold and seal rollers. Now take a dry cloth and wipe off excess toner. The cloth should be covered with black toner surplus from cleaning the rollers.
4. Make sure to run 10-15 sheets of blank copy paper to ensure all cleaner has been removed from the fold rollers. Running blank sheets will remove any excess residue of cleaner on the rollers.

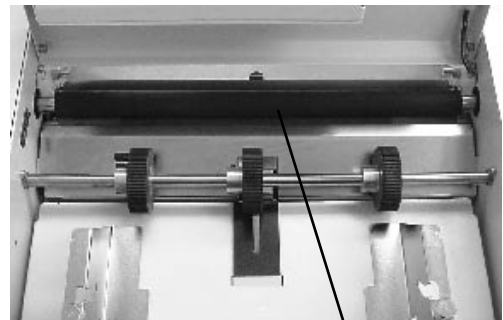

Fig. 13

Fold Rollers

TROUBLE-SHOOTING

TROUBLE	POSSIBLE CAUSE	REMEDY
Control panel lights are not illuminated.	No power at the wall outlet.	Check wall outlet.
	No power to the machine inlet.	Check power cord for frayed/broken wires.
	No power to the control panel.	Press the button on the circuit breaker.
	Internal electrical failure	Call for service
Fold plate stop not moving when "Test"/"Start" is pressed.	Fold plate is not plugged in.	Plug fold plate in.
	Electrical or mechanical failure.	Call for service
"Cover Open" is displayed.	Cover open	Close cover
	Magnetic switch is broken.	Call for service
"Paper out " is displayed.	In-feed tray is empty.	Place documents on the in-feed tray.
"Paper Jam" is displayed.	Paper jammed in folder.	Remove paper and press "Counter Reset" button.
Black marks on the folded paper.	In-feed tires, separator, and/or fold rollers are dirty.	Clean the parts with approved roller cleaner and rejuvenator.
Fold is skewed.	In-feed tray is out of adjustment.	Turn skew adjuster knob to remove the skew.
Stacker belts do not turn.	Broken drive belt, worn drive gear.	Call for service
Documents are wrinkled or crunched.	Fold plates are not inserted correctly.	Remove and reinstall fold plates. Be sure they're properly positioned.
	Piece of paper or other material is stuck in the fold plate.	Remove object from the fold plate.
In-feed tray lever does not work	Broken spring	Call for service
Double feeding forms	Documents stuck together	Jog forms to remove static electricity.
	Feed tire or separator worn	Call for service
Not feeding documents	Feed tire dirty	Clean feed tire
	Feed tire or separator worn	Call for Service